

DESCRIPTION

This is EV board documentation for MP1907. The MP1907 is a high frequency, 100V half bridge N-channel power MOSFET driver. Its low side and high side driver channels are independently controlled and matched with a time delay of less than 5ns. Under-voltage lockout on both high side and low side supplies force their outputs low in case of insufficient supply. The integrated bootstrap diode reduces external component count.

This demo board is configured to a buck converter. INH and INL are independent signals of each other. For simplicity, the user only need to supply a PWM signal to this demo board and the on-board circuitry will generate INH and INL signals with proper dead time. In a real system, the controller will have to take care of dead time adjustment.

ELECTRICAL SPECIFICATION

| Parameter | Symbol | Value | Units |
|---------------------|--------------------|--------|-------|
| Driver Voltage | V _{DD} | 6 – 18 | V |
| Input Power Voltage | V _{POWER} | 0-100 | V |
| Duty | | 10 | % |
| Output Current | I _{OUT} | 2.5 | A |
| Frequency | F _{SW} | 200 | kHz |

FEATURES

- Drives N-Channel MOSFET Half Bridge
- 100V V_{BST} Voltage Range
- On-Chip Bootstrap Diode
- Typical 20ns Propagation Delay Time
- Less Than 5ns Gate Drive Matching
- Drives 1nF Load with 12ns/9ns Rise/Fall Times with 12V V_{DD}
- TTL Compatible Input
- Less Than 150µA Quiescent Current
- UVLO for Both High Side and Low Side
- In QFN10 3x3mm Packages

APPLICATIONS

- Telecom Half Bridge Power Supplies
- Avionics DC-DC Converters
- Two-Switch Forward Converters
- Active Clamp Forward Converters

All MPS parts are lead-free and adhere to the RoHS directive. For MPS green status, please visit MPS website under Quality Assurance.

"MPS" and "The Future of Analog IC Technology", are Registered Trademarks of Monolithic Power Systems, Inc.

EV1907-Q-00A EVALUATION BOARD



(L x W x H) 6.4cm x 6.4cm x 3cm

| Board Number | MPS IC Number |
|--------------|---------------|
| EV1907-Q-00A | MP1907GQ |

EVALUATION BOARD SCHEMATIC

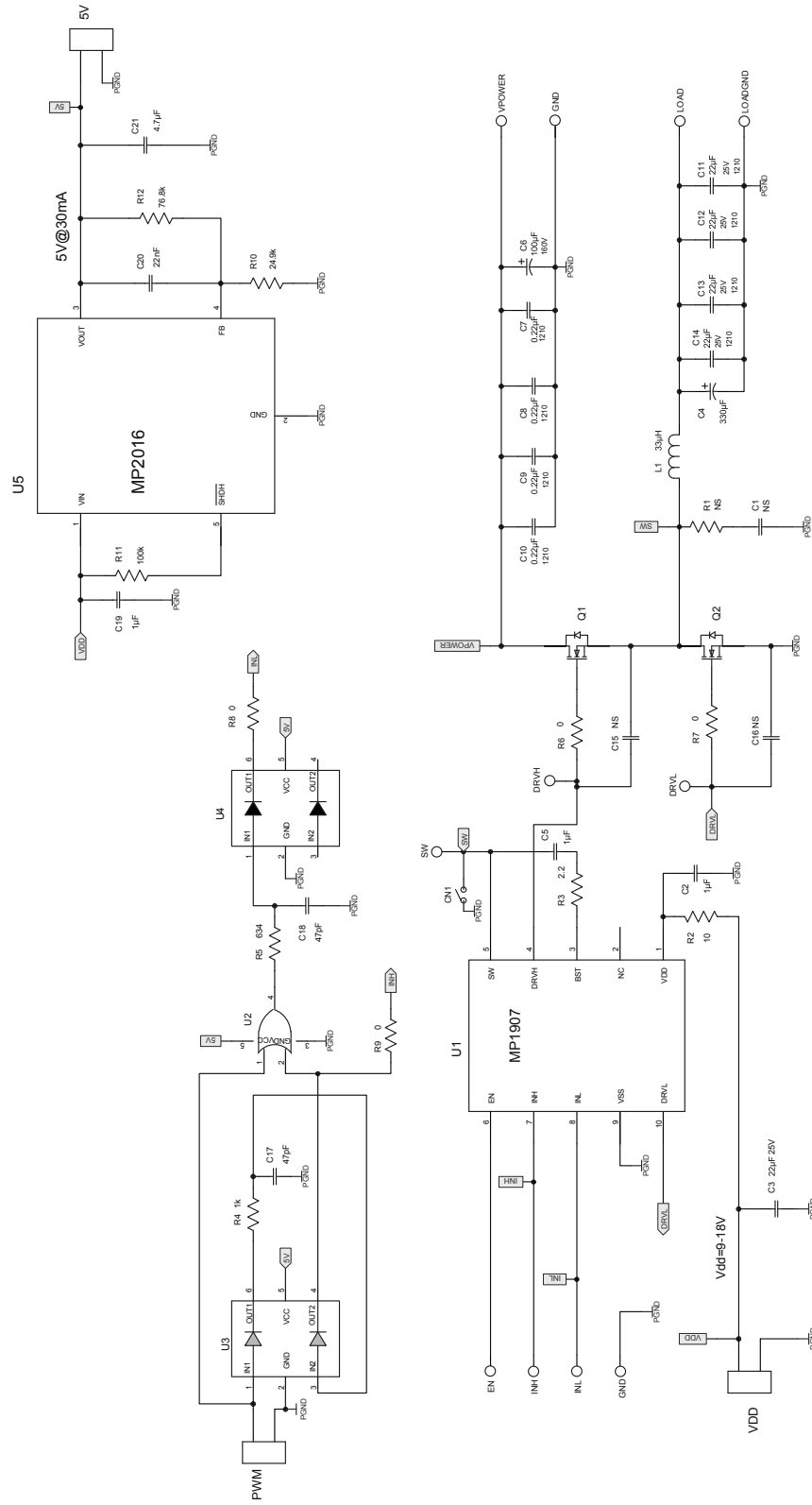

EV1907-Q-00A BILL OF MATERIALS

| Qty | RefDes | Value | Description | Package | Manufacturer | Manufacturer P/N |
|-----|------------------------|--------------|------------------------------|-------------|-------------------------|--------------------|
| | C1 | NS | | 0805 | | |
| 3 | C2, C5, C19 | 1.0 μ F | Ceramic Cap, 25V, X7R | 0603 | MuRata | GRM188R71E105KA12D |
| 1 | C3 | 22 μ F | Ceramic Cap, 25V, X5R | 1206 | MuRata | GRM31CR61E226KE15L |
| 1 | C4 | 330 μ F | 25V Elec. Alu. Cap | SMD | Sanyo | 25JZV330MINS |
| 1 | C6 | 100 μ F | 160V, Aluminium Cap | 12.5X25X5mm | ZHN | CD11-160V-100UF |
| 4 | C7, C8, C9, C10 | 0.22 μ F | Ceramic Cap, 250V | 1210 | MuRata | GRM32DR72E224KW01 |
| 4 | C11, C12, C13, C14 | 22 μ F | Ceramic Cap, 25V, X5R | 1210 | MuRata | GRM32ER61E226KE15L |
| | C15, C16 | NS | | 0603 | | |
| 2 | C17, C18 | 47pF | Ceramic Cap, 50V, C0G | 0603 | MuRata | GRM1885C1H470JA01D |
| 1 | C20 | 22nF | Ceramic Cap, 25V, X7R | 0603 | MuRata | GRM188R71E223JA01D |
| 1 | C21 | 4.7 μ F | Ceramic Cap, 6.3V, X5R | 0603 | MuRata | GRM188R60J475ME19D |
| | CN1 | NS | Jumper | | | |
| 1 | L1 | 33 μ H | DCR=21.7m Ω , Isat=9A | 18x18x9mm | Würth | WE74435573300 |
| 2 | Q1, Q2 | Mosfet | 150V, 6.5A MOSFET | Single N | Analog Power | MP4394N |
| | R1 | NS | | 0603 | | |
| 1 | R2 | 10 Ω | Film Resistor, 5% | 0603 | Yageo | RC0603JR-0710RL |
| 1 | R3 | 2.2 Ω | Film Resistor, 5% | 0603 | Yageo | RC0603JR-072R2L |
| 1 | R4 | 1k | Film Resistor, 1% | 0603 | Yageo | RC0603FR-071KL |
| 1 | R5 | 634 Ω | Film Resistor, 1% | 0603 | Yageo | RC0603FR-07634RL |
| 4 | R6, R7, R8, R9 | 0 Ω | Film Resistor | 0603 | Yageo | RC0603JR-070RL |
| 1 | R10 | 24.9k | Film Resistor, 1% | 0603 | Yageo | RC0603FR-0724K9L |
| 1 | R11 | 100k | Film Resistor, 1% | 0603 | Yageo | RC0603FR-07100KL |
| 1 | R12 | 76.8k | Film Resistor, 1% | 0603 | Yageo | RC0603FR-0776K8L |
| 1 | VDD, INH | Test Point | 11 Pin Header, 2.54mm | 0.1x11 | Sullins | PCC11SAAN |
| 4 | VPOWER, GND, GND, LOAD | Test Point | 2.3 pillar | W200D100 | CD | China |
| 1 | U1 | MP1907 | 100V Half Bridge Driver | QFN10 3x3 | MPS | MP1907GQ-R1 |
| 1 | U2 | OR Gate | 2-input OR Gate | SOT23-5 | Fairchild Semiconductor | NC7S32M5 |
| 2 | U3, U4 | Inverter | Dual Inverter | SC70 | Fairchild Semiconductor | NC7WZ14P6X |
| 1 | U5 | MP2016 | LDO, 5V, 30mA | SOT23-5 | MPS | MP2016DJ |

EVB TEST RESULTS

Performance waveforms are tested on the evaluation board.

$V_{POWER} = 100V$, $V_{DD} = 12V$, $I_{LOAD} = 2.5A$, Duty=10%, $L = 33\mu H$, Frequency=200kHz, $T_A = 25^\circ C$, unless otherwise noted.

INH to DRVH Delay with MOSFET

V_{POWER} is not applied

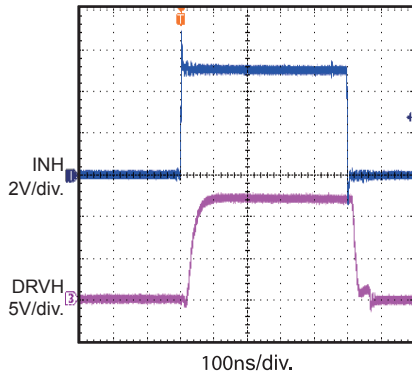

INL to DRVL Delay with MOSFET

V_{POWER} is not applied

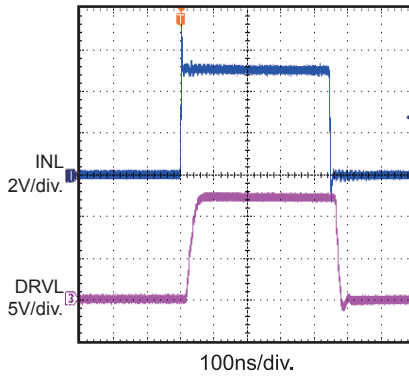

Generated INH and INL from PWM

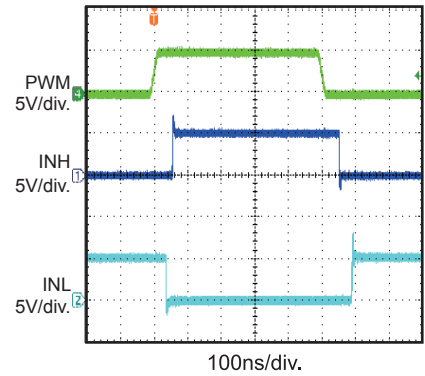

Input Signals and SW Node

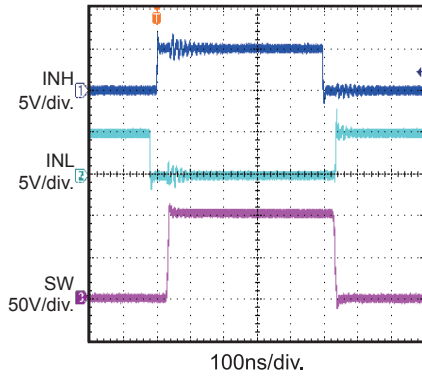

PRINTED CIRCUIT BOARD LAYOUT

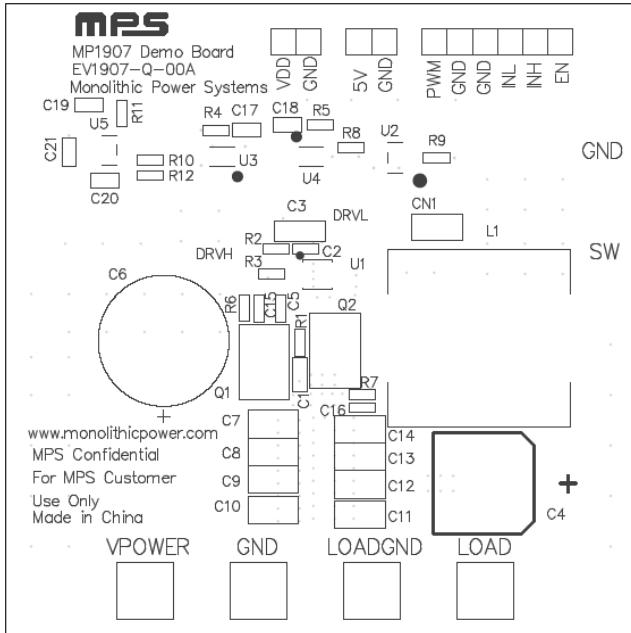

Figure 1—Top Silk Layer

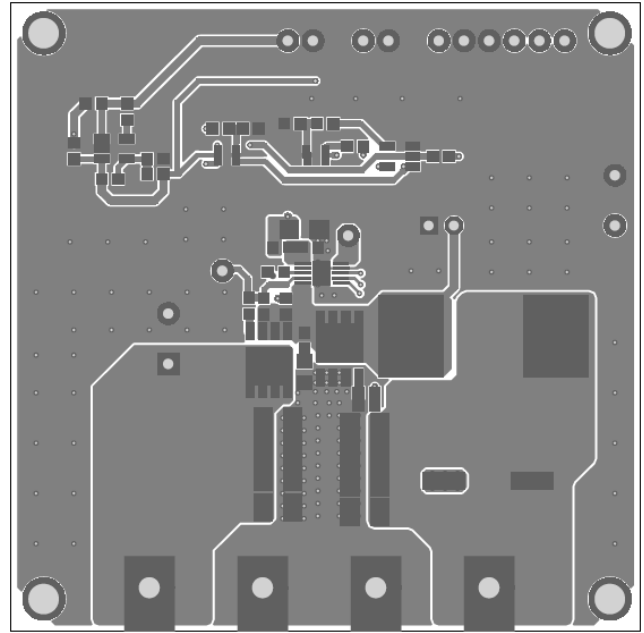

Figure 2—Top Layer

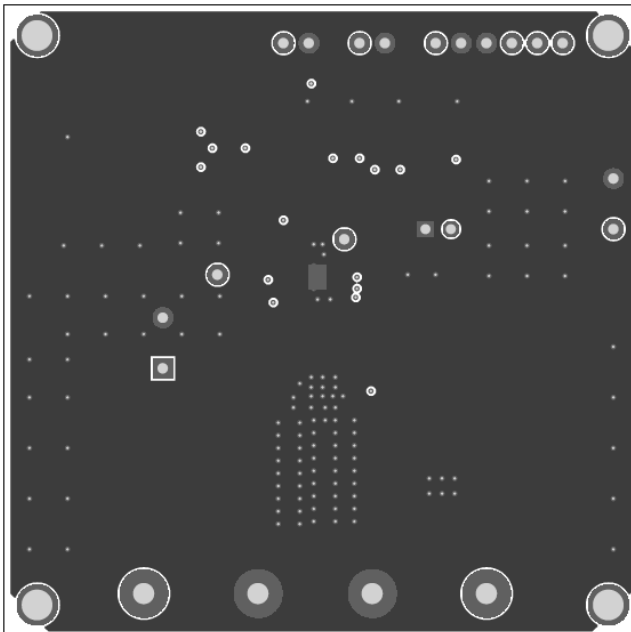

Figure 3—Inner 1 Layer & Inner 2 Layer

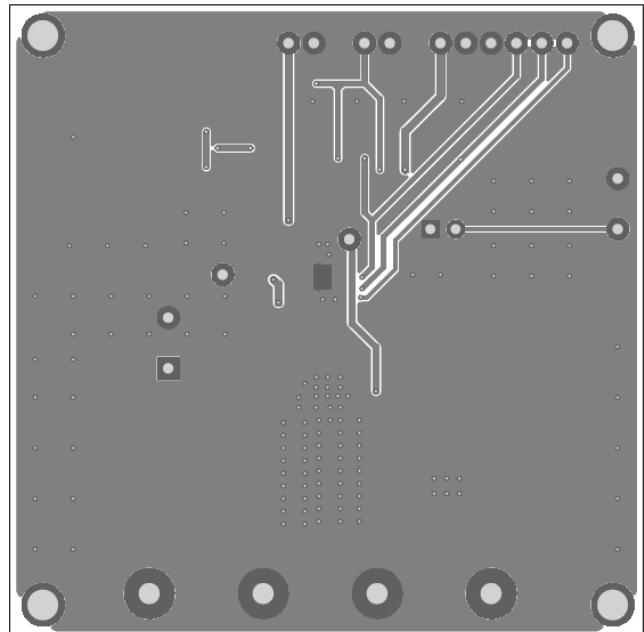

Figure 4—Bottom Layer

QUICK START GUIDE

EV1907-Q-00A is configured in a buck converter. Below is the recommended setting for users to evaluate the EV board. User must watch for inductor saturation (do not set switching frequency too low) and over temperature (do not increase duty).

1. Preset Driver Power Supply between 6V-18V.
2. Preset Input Power Supply between 0V-100V.
3. Preset EN Power Supply between 1.5V- 18V
4. Connect Driver Power Supply terminals to:
 - a. Positive (+): VDD
 - b. Negative (-): GND
5. Connect Input Power Supply terminals to:
 - a. Positive (+): VPOWER
 - b. Negative (-): GND
6. Connect Load to:
 - a. Positive (+): LOAD
 - b. Negative (-): LOADGND
7. Function Generator setting:
 - a. Frequency: 200 kHz
 - b. Logic High: 5V
 - c. Logic Low: 0V
 - d. Duty: 10%
 - e. Rising/Falling Edge Slew Rate: As fast as possible
8. Connect Function Generator's output to PWM and GND pins. Turn on Function Generator's output.
9. Turn on Driver Power Supply.
10. Check INH, INL, DRVH and DRVL signals. Make sure there are dead time between DRVH high and DRVL high to avoid shoot through.
11. If all signals are correct, then turn on Input Power Supply.
12. User may load up to 2.5A of output current. Higher load current may cause overheat to the MOSFET.
13. To turn off the board, please follow these steps:
 - a. Turn off load.
 - b. Turn off Input Power Supply.
 - c. Turn off Driver Power Supply.

NOTICE: The information in this document is subject to change without notice. Please contact MPS for current specifications. Users should warrant and guarantee that third party Intellectual Property rights are not infringed upon when integrating MPS products into any application. MPS will not assume any legal responsibility for any said applications.

Mouser Electronics

Authorized Distributor

Click to View Pricing, Inventory, Delivery & Lifecycle Information:

[Monolithic Power Systems \(MPS\):](#)

[EV1907-Q-00A](#)